

A slip ring can be used in any electromechanical system that requires unrestrained, continuous rotation while transferring power or data from a stationary to a rotating structure. A slip ring is also called a rotary electrical interface, collector, swivel or a commutation. A slip ring can improve system performance by simplifying operations and eliminating damage-prone wires dangling from movable joints.

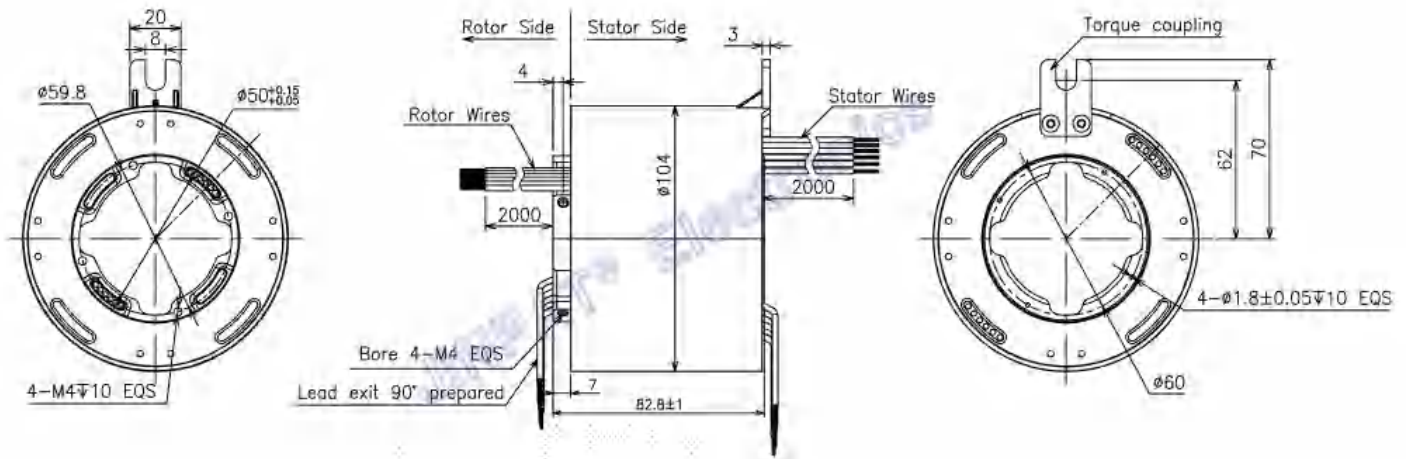

Electronic & Electric			Mechanical	
Circuits	Total	12CKT	Working Speed	0~400rpm
	Detail	12X10A	Contact Material	Fiber Brush
Rating Voltage		500VAC/DC	Housing Material	Fibre-reinforced plastics
Dielectric Strength		500VAC@60Hz	Lead Wire Length	Stator:2m Rotor:2m
Insulation Resistance		≥1000MΩ@500VDC	Inner Diameter	φ50mm
Environment			Remarks	
Working Temperature		-40°C~+80°C	IP	IP54 (Horizontal installation)
Working Humidity		≤60%RH		