

Fiber Optic Rotary Joints (FORJs) are to optical signals what electrical slip rings are to electrical signals, a means to pass signals across rotating interfaces, particularly when transmitting large amounts of data.

FORJs maintain the intrinsic advantages of fiber end to end. JINPAT has been producing Fiber Optic Rotary Joints for over Twenty-five years..

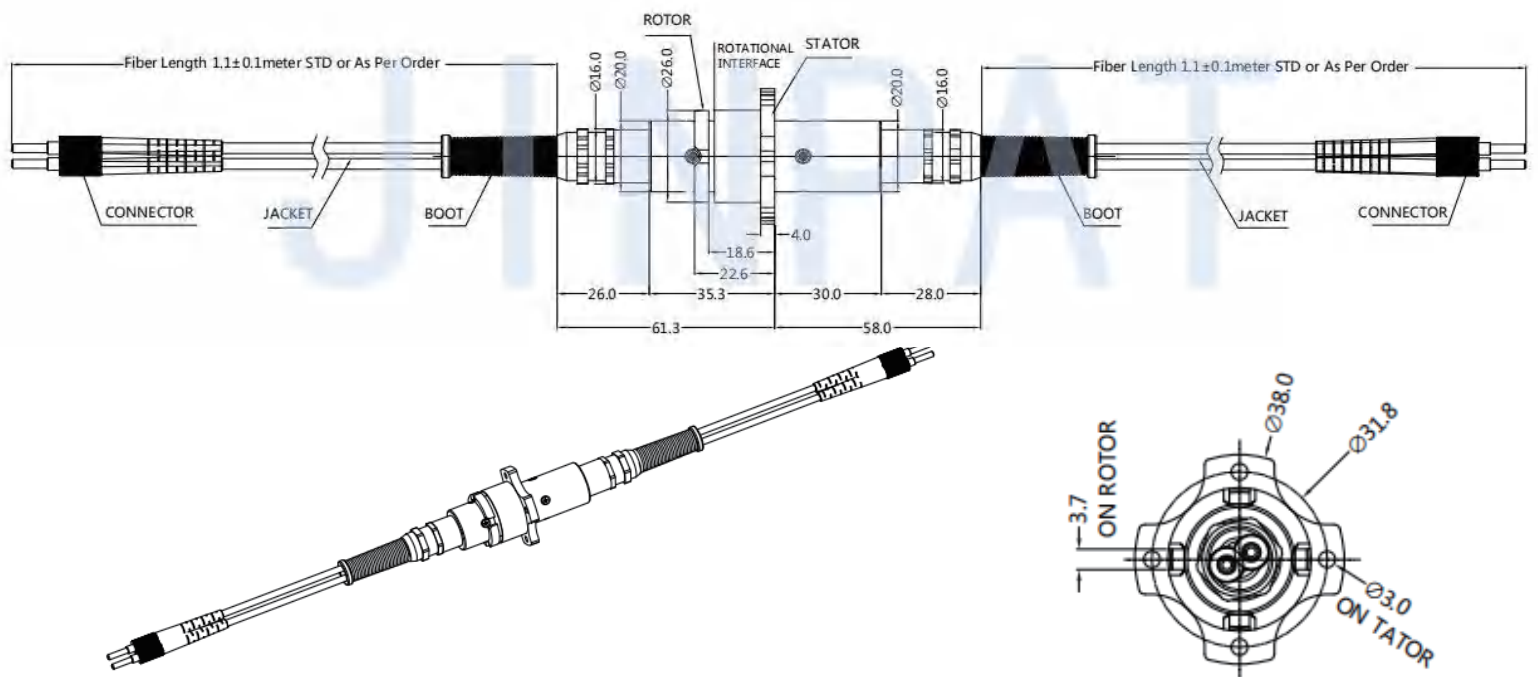

Specifications

Fiber types	SM or MM	Connector types	FC/SC/ST/LC(PC or APC)
Channel number	3	Estimated life cycle	> 100 million revolutions
Wavelength range	SM:1310-1550nm MM:850-1300nm	Vibration	MIL-STD-167-1A
Insertion loss	<4dB	Mechanical shock	MIL-STD-810G
Insertion loss ripple	<2dB	IP rating	IP65 or IP67
Return loss	SM:≥45dBMM:≥30dB	Maximum speed	300rpm
Max Optical power	23dBm	Package style	Pigtails on both ends
Working temperature	-20~+65°C(Industrial grade) -50~+80°C (Military grade)	Crosstalk	≥50dB
Storage temperature	-55~+85°C	Weight approx	200g (No tail cable and connection included)