

Description

A slip ring can be used in any electromechanical system that requires unrestrained, continuous rotation while transferring power or data from a stationary to a rotating structure. A slip ring is also called a rotary electrical interface, collector, swivel or a commutator. A slip ring can improve system performance by simplifying operations and eliminating damage-prone wires dangling from movable joints.

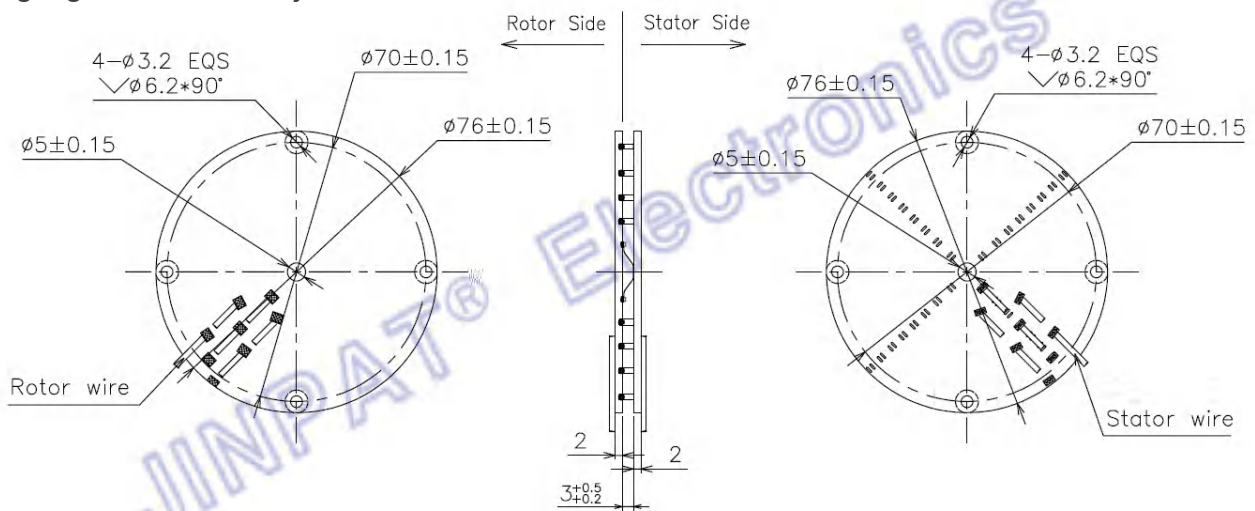

Electronic & Electric			Mechanical	
Circuits	Total	6CKT	Working Speed	0~100rpm
	Detail	6x5A	Contact Material	Precious Metal
Rating Voltage		240V	Housing Material	FR-4
Dielectric Strength		300VAC@50Hz	Lead Wire Length	Stator:300mm Rotor:300mm
Insulation Resistance		$\geq 300M\Omega @ 300VDC$	Inner Diameter	$\phi 5.0mm$
Environment			Remarks	
Working Temperature		$-20^\circ C \sim +60^\circ C$	Application	/
Working Humidity		$\leq 60\%RH$	Other	/
IP		/	Note: "P" stands for power, "S" stands for signal.	