

Features:

- ◆ 24 circuits models
- ◆ 1 amps per circuit , 240 VAC/DC
- ◆ Precision assembly to provide exceptional rotational life
- ◆ Speed up to 300 rpm continuous
- ◆ Gold-Gold contacts
- ◆ Flexible, color-coded, silver-plated, stranded copper lead wire
- ◆ Superior handling of low level control signals
- ◆ Metal housing optional

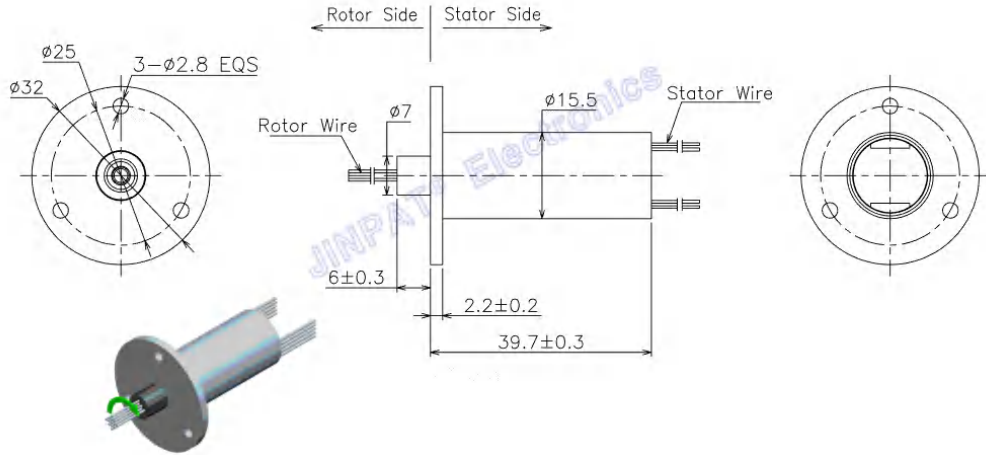

Electronic & Electric			Mechanical	
Circuits	Total	24CKT	Working Speed	0~300rpm
	Detail	24x1A (You can go through 2A under certain circumstances)	Contact Material	Gold to Gold
Rating Voltage		110V AC/DC	Housing Material	Engineering plastics
Dielectric Strength		$\geq 200\text{VAC}@50\text{Hz(P)}$ $\geq 100\text{VAC}@50\text{Hz(S)}$	Lead Wire Length	Stator: $250\pm 5\text{mm}$ Rotor: $250\pm 5\text{mm}$
Insulation Resistance		$\geq 50\text{M}\Omega@200\text{VDC(P)}$ $\geq 10\text{M}\Omega@100\text{VDC(S)}$	Dynamic Resistance Fluctuation Value	$\leq 35\text{m}\Omega$
Environment			Remarks	
Working Temperature		$-20^{\circ}\text{C}\sim +60^{\circ}\text{C}$	Application	/
Working Humidity		$\leq 60\%\text{RH}$	Other	/
IP		IP40	Note: "P" stands for power, "S" stands for signal.	