

LPMS Super Miniature Capsule Slip Ring is able to integrate 12 or more circuits, with optional outer diameter from 5.5mm~11.1mm. This series is super mini size, with precise design using military-standard material.

Features:

- ◎ Ultra compact size/ Precise design /
- Military-standard material / Low resistance

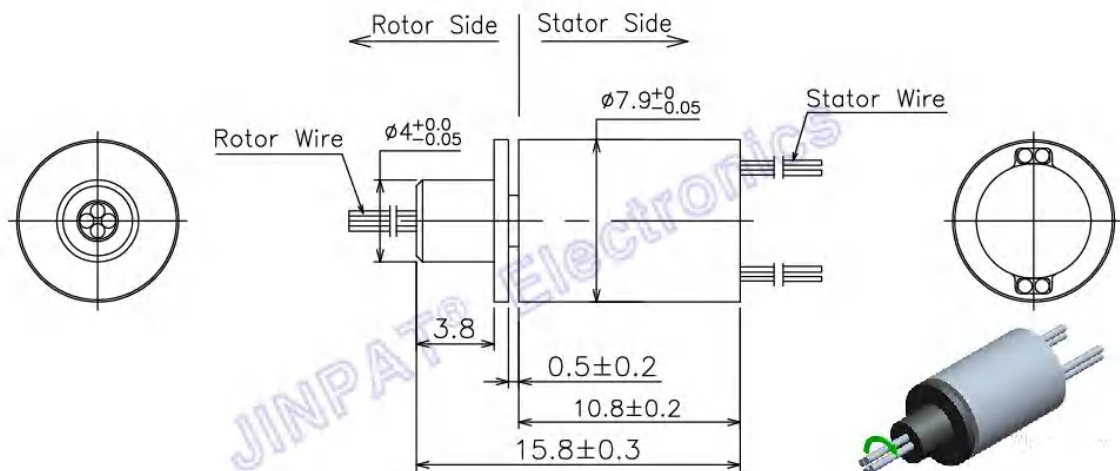

Electronic & Electric		Mechanical		
Circuits	Total	4CKT	Working Speed	0~300rpm
	Detail	4x1A	Contact Material	Gold to Gold
Rating Voltage		48V AC/DC	Housing Material	Stainless Steel
Dielectric Strength		≥100VAC@50Hz	Lead Wire Length	Stator:250±5mm Rotor:250±5mm
Insulation Resistance		≥50MΩ@100VDC	Dynamic Resistance Fluctuation Value	≤35mΩ
Environment		Remarks		
Working Temperature		-20°C~+60°C	Application	/
Working Humidity		≤60%RH	Other	/
IP		IP40	Note: "P" stands for power, "S" stands for signal.	