

### Features

- ◆ 6, 12, 18 and 24 circuits models
- ◆ Precious metal contacts
- ◆ 5 amps rings
- ◆ Precision ball bearings for long life
- ◆ Speed up to 500 rpm continuous
- ◆ Compact size
- ◆ Sealed units available
- ◆ Flying leads
- ◆ Fully compatible with both analog and TTL control level signals
- ◆ Rugged black anodized aluminum construction



### Advantages

- ◆ Unique signal handling performance with minimal electrical noise
- ◆ Compact design to fit in the most demanding space constraints
- ◆ Low torque minimizes system torque budget
- ◆ Rapid delivery

Electronic & Electric			Mechanical	
Circuits	Total	6CKT	Working Speed	0~300rpm
	Detail	6x5A	Contact Material	Precious Metal
Rating Voltage		240VAC/DC	Housing Material	Aluminum alloy
Dielectric Strength		1000VAC@50Hz	Lead Wire Length	Stator:300mm Rotor:300mm
Insulation Resistance		≥500MΩ@500VDC	Inner Diameter	φ96mm
Environment			Remarks	
Working Temperature		-20°C~+60°C	Other	/
Working Humidity		≤60%RH		

### LPT096-0605-Outline Drawing

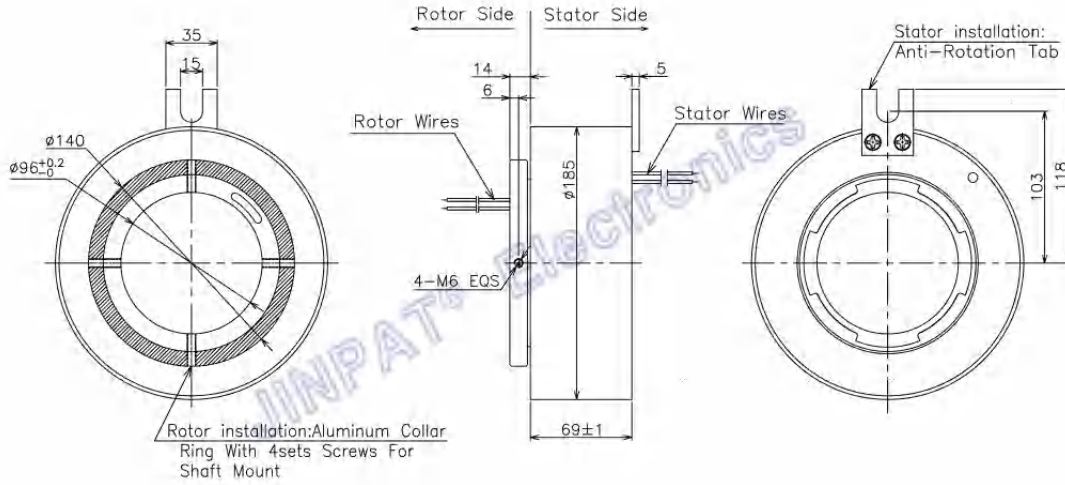

### LPT096-0610-Outline Drawing

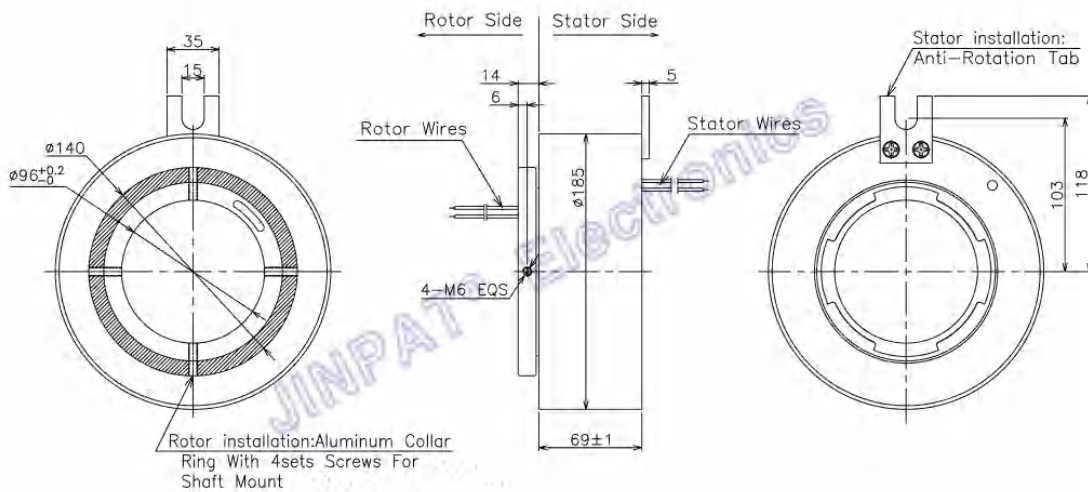

### LPT096-0615-Outline Drawing

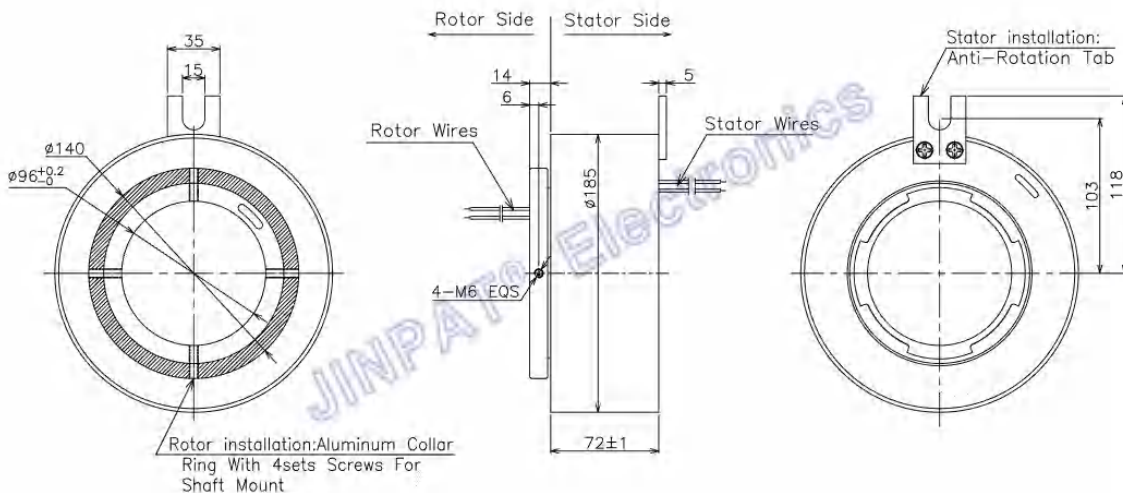

### LPT096-1205-Outline Drawing

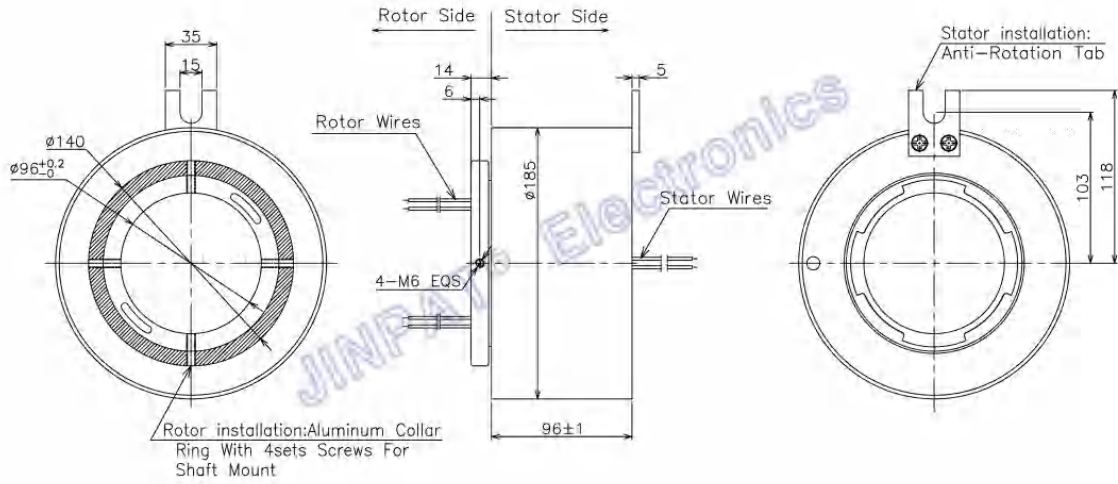

### LPT096-1210-Outline Drawing

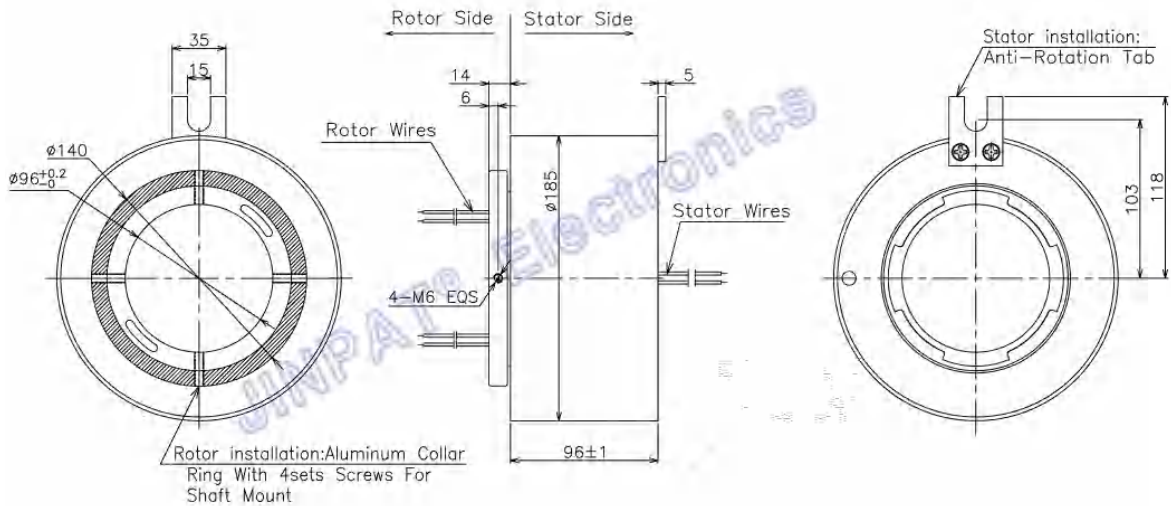

### LPT096-1215-Outline Drawing

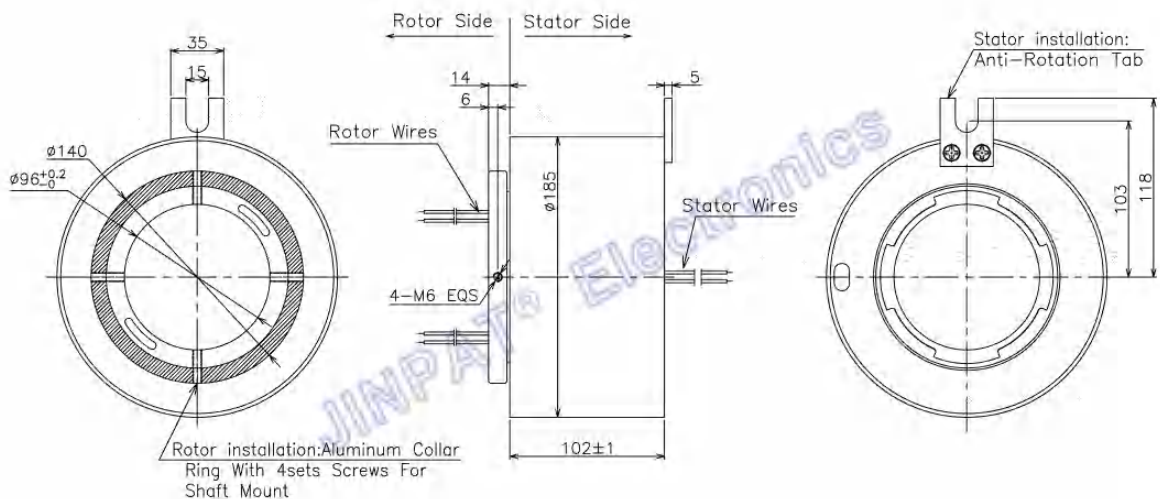

### LPT096-1805-Outline Drawing

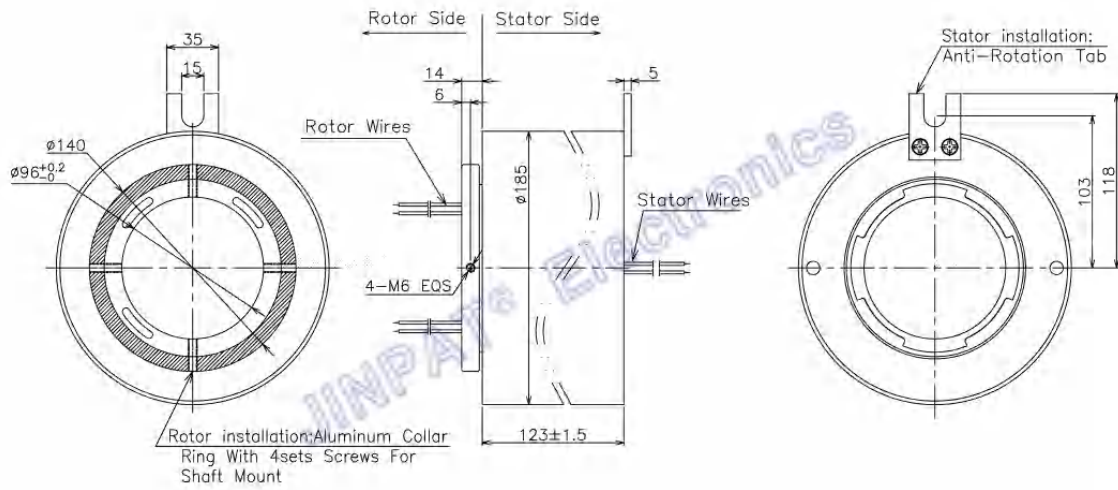

### LPT096-1810-Outline Drawing

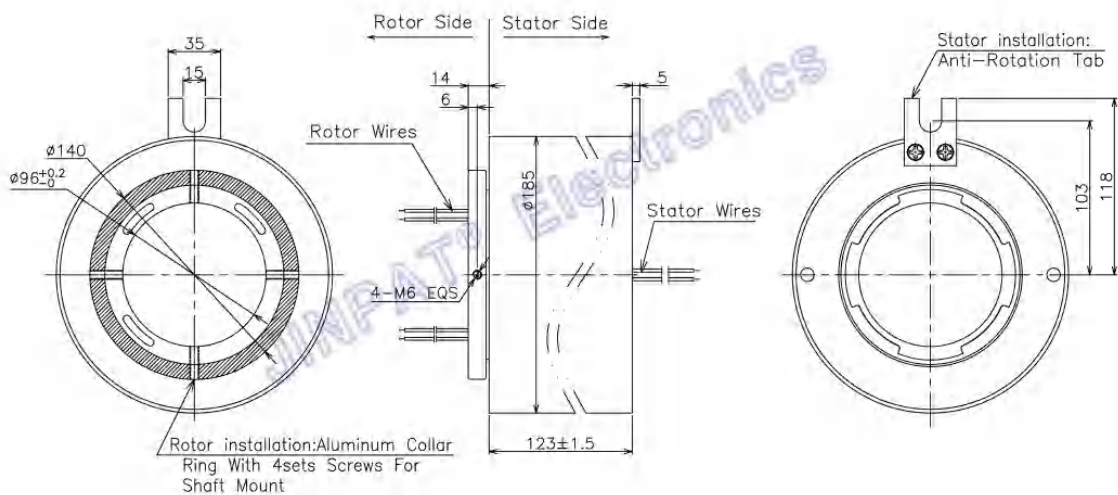

### LPT096-1815-Outline Drawing

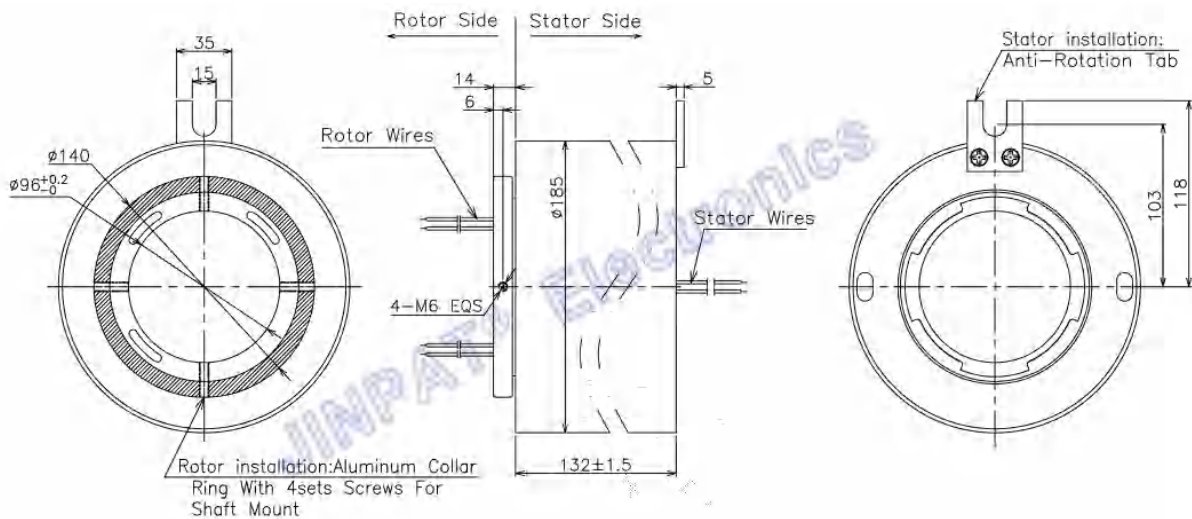

### LPT096-2405-Outline Drawing

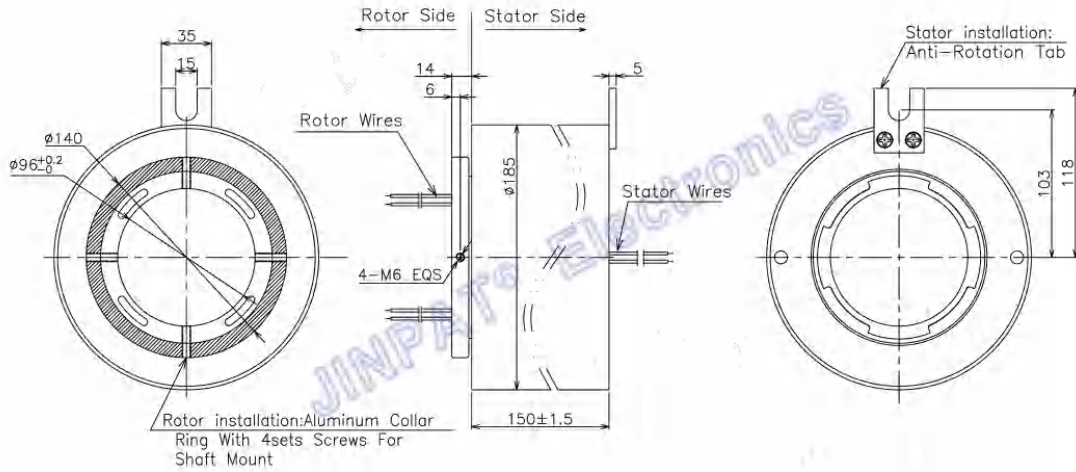

### LPT096-2410-Outline Drawing

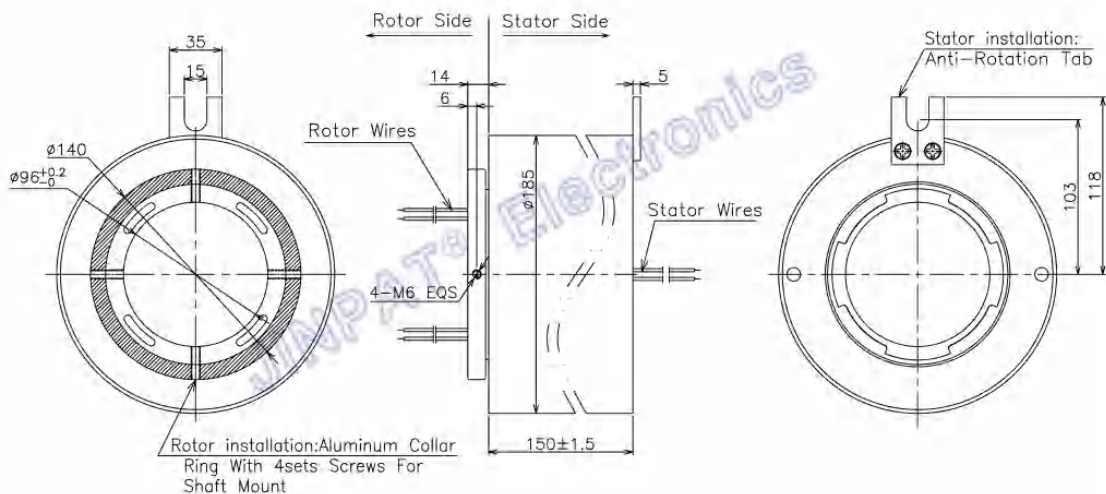

### LPT096-2415-Outline Drawing

